

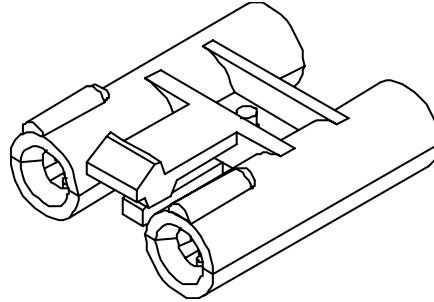

UL Recognized Receptacle Polarized for +24 Volts



Part #:	KS21103L7
Certifications:	UL Recognized Receptacle Meets requirements of RoHS Directive 2002/95/EC
Flammability: Rating	UL 94V0
Mass:	16.4 grams
Oxygen Index:	35 %
Polymer %:	58.6%
Housing:	Lexan® 940 (polycarbonate)
Contacts:	Tin Plated Copper with Stainless Steel Springs
Fastener:	Zinc Plated Steel